



## USAGE AND CARE GUIDE

PRODUCT CODES:

EA60SDSXL  
EA60SDSXR  
EA60WFBL  
EA60WFBR  
EA60WFSX2L  
EA60WFSX2R  
EA60WSDBL  
EA60WSDBR  
EA900SDSX  
EA900WFBL  
EA900WFSX2  
EA900WSDB

# **INDEX**

## **INSTALLATION**

Safety Information

Recommendations before loading & plugging in the beverage cooler

Grounding Instructions

Assembly

Levelling Your Beverage Cooler

## **OPERATING YOUR BEVERAGE COOLER**

Defrosting/hygrometry/condensation/ventilation

Temperature setting

Beverage Cooler Control panel

Cooling Indicator light

Interior Light

Installing Stainless Steel Handle

Power Failures and Operation Anomalies

## **CARE AND MAINTENANCE**

Clean the condenser

Care when going on Vacation

Moving your Beverage Cooler

Energy saving tips

Recommended Cleaning Product

## **TROUBLESHOOTING GUIDE**

### **TECHNICAL SPECIFICATIONS**

EA60 Series Stainless Steel Beverage Cooler

EA60 Series Black Beverage Cooler

EA90 Series Beverage Cooler

### **WIRING DIAGRAM**

EA60 Series

EA90/900 Series

### **DIMENSION DRAWINGS**

EA90/900 Series

EA60 Series

### **SPARE PARTS**

## INSTALLATION

### Safety Information

#### Warning

**All electrical work must be carried out by suitably qualified persons**

This beverage cooler is an outdoor appliance. This appliance is intended for household use only. It is designed to be used in sheltered areas only and must not be exposed to the elements. It can be installed in an alfresco area in accordance with the following:

- Unit must not be exposed to direct sunlight, rain, moisture or dust.
- Do not install in a location where winds may blow water or dust on to the beverage cooler.
- The appliance must not be operated or left out in the weather.
- Do not expose the outdoor appliance to rain or wet conditions.

#### Warning

**This beverage cooler should only be use for the storage of beverages. It must not be used to store food.**

Euro Appliances offers no guarantee for our beverage cooler if it is being used for any purpose other than that for which it was specially designed. Euro Appliances is not responsible or liable for any spoilage or damage to beverages or any other contents incidental or consequential to possible defects of the beverage cooler. Warranty applies to the beverage cooler only and not to the contents of the beverage cooler.

This appliance is not intended for use by persons (including children) with reduced physical, sensory or mental capabilities, or lack of experience and knowledge, unless they have been given supervision or instruction concerning use of the appliance by a person responsible for their safety.

Children should be supervised to ensure they do not play with the appliance.

Allow 24 hours before switching on the beverage cooler. During this time, we recommend that you leave the door open to clear any residual odours.

## Recommendations before loading & plugging in the beverage cooler

- Be unencumbered and well ventilated;
- Be well away from any heat source and direct sunlight or rain;
- Not be too damp (laundry, pantry, bathroom, garage and basement, etc.);
- Have a flat, level and dry floor;
- Have a standard and reliable electricity supply (10A General purpose outlet properly earthed). It is not recommended to use a multi-socket or extension lead;
- Have a surge protector fitted to the electrical outlet.
- Away from microwave. Certain microwave ovens do not have wave interference shield. When placed within 1 meter of the beverage cooler, they may affect the operation of the beverage cooler. Always ensure the outdoor display fridge is kept at the correct settings for the required operation of the appliance.
- Do not store explosive substances, such as aerosol cans with flammable propellant, in this appliance.

The beverage cooler should be placed where the ambient temperature is between 2 °C to 40 °C. If the ambient temperature is above or below this range, the performance of the unit may be affected. Placing your unit in extreme cold or hot conditions may cause interior temperatures to fluctuate and the ideal range of temperature may not be reached.

### Warning

**Keep ventilation openings, in the appliance enclosure or in the built-in structure, clear of obstruction.**

**Do not use mechanical devices or other means to accelerate the defrosting process, other than those recommended by the manufacturer.**

**Do not use electrical appliances inside the food storage compartments of the appliance, unless they are of the type recommended by the manufacturer.**

**Do not damage the refrigerant circuit.**

**This product should not be disposed by the customers, please contact your local authorities and ask for the correct method of disposal. Incorrect disposal may expose the user to injury from sharp objects, flammable gases or cause environmental damage.**

### Grounding Instructions

The beverage cooler must be grounded in case of an electrical short circuit. Grounding reduces the risk of electrical shock. The beverage cooler is equipped with a power cord having a grounding wire and plug. The beverage cooler plug must be plugged into properly installed and grounded electrical outlet. In locations

where there is frequent lightning, it is advisable to use surge protectors.

Improper use of the grounding plug can result in the risk of electric shock. Consult a qualified electrician or service person if the grounding instructions are not completely understood.

If the supply cord is damaged, it must be replaced by the manufacturer, its service agent or similarly qualified persons in order to avoid a hazard.

### Assembly

- Remove the appliance from the packaging and peel off any protective film from all surfaces.
- Fit the shelf support clips onto the shelf support strips, making sure that the clips for each shelf are of the same height and that they are securely engaged on the support strip.
- Unwrap each shelf carefully, to prevent damaging their protective coating or surface finish.
- Position the shelves onto the clips.
- Please note the following maximum shelf loading weights: 20Kg.



### Important

**Before connecting the unit to a power source, please let it stand upright for approximately 24 hours. This will reduce the possibility of a malfunction in the cooling system from handling during transportation.**

The beverage cooler must be positioned so that the plug is accessible. Release the power cord and move your beverage cooler to the selected location. The beverage cooler should be installed in a suitable place where the compressor will not be subject to physical contact.

### Important

**For freestanding installation, the beverage cooler requires 30mm gap on both sides as well as the rear. This allows the proper air circulation to cool the compressor and condenser. For built-in installation, the beverage cooler requires 10mm space on each side and at the top as well as 30mm space at the rear. The air vent at the front must never be covered or blocked in any way.**

### Levelling Your Beverage Cooler

Beverage cooler must be levelled before loading your beverages. Your beverage cooler is equipped with 4 adjustable feet to facilitate easy levelling.



## OPERATING YOUR BEVERAGE COOLER

1. Turning on your beverage cooler. Plug in and switch on the beverage cooler by pressing on the power button for a few seconds. When you use the beverage cooler for the first time (or restart the beverage cooler it has been switch off for a long time), there will be a few degrees variance between the temperature you have selected and the one indicated on the LED readout. This is normal and it is due to the length of the activation time. Once the beverage cooler is running for a few hours everything will stabilize.

### Important

**If the unit is unplugged, power is lost or switched off, wait 3 or 5 minutes before restarting the unit.  
The beverage cooler might not start if you attempt to restart before this time delay.**

2. Operating noises. To reach the desired temperature settings, Euro beverage cooler, like all beverage coolers operating with compressors and fans, may produce the following types of noises. These noises are normal and occur as follows:
  - Gurgling sound, caused by the refrigerant flowing through the appliance's coils;
  - Cracking/popping sounds, resulting from the contraction and expansion of the refrigerant gas to produce cold;
  - Fan operating sound, to circulate the air within the beverage cooler.
3. Loading your beverage cooler. You might load your cans or bottles standing or lying in single or double rows while taking note of the following:
  - If you do not have enough cans or bottles to fill your beverage cooler, it is better to distribute them throughout the beverage cooler to avoid "all on top" or "all below" type loads.
  - Remove or relocate metal racks to accommodate large type of cans or bottles where necessary.
  - Keep small gaps between the wall and the cans or bottles to allow air circulation.
  - To facilitate air circulation, do not over load your beverage cooler.
  - Avoid obstructing the internal fan (located inside on the back panel of the beverage cooler)
  - To prevent the cans or bottles from falling, do not try to slide the racks outwards beyond the fixed position.

## Important

**Do not pull out more than one loaded rack at a time as this may cause the beverage cooler to tilt forward.**

**Do not cover the metal racks with aluminum foil or other materials, as it will obstruct air circulation.**

**Do not move your beverage cooler while it is loaded with beverages. This may distort the main cabinet.**

**Do not store explosive substances such as aerosol cans with a flammable propellant in this appliance.**

## Defrosting/Hygrometry/Condensation/Ventilation

Your beverage cooler is designed with auto defrost system. The defrost water from the beverage cooler storage compartment drains automatically and part of it goes into a drainage container, which is located at the back of the beverage cooler next to the compressor. The heat is transferred from the compressor and evaporates any condensation that has collected in the pan. Part of the remaining water is collected within the beverage cooler for humidity purposes.

All Euro beverage coolers are equipped with a triple glazed glass door to minimize condensation on the glass door. The unit is not totally sealed, fresh air admission is permitted through the drainpipe. Air is circulated through the beverage cooler by means of a fan /fans and the hollow shelves.



## Important

**The water collected by condensation, is therefore recycled. Under extremely dry environmental conditions, you may have to add some water into the water container provided with your beverage cooler. During the refrigerating cycle, heat is given off and disperses through the external surfaces of the beverage cooler.**

**Avoid touching the surfaces during those cycles.**

## Temperature Setting

Depending on the loading and settings chosen, it takes 24 hours for the beverage cooler temperature to stabilize. During this time, the LED temperature display may seem to move erratically. This is a normal process. This process occurs whenever the setting is modified and/or whenever large amounts of cans or bottles are added to the beverage cooler. In the event of a power interruption, all previous temperature settings are automatically erased and it will revert to the pre-set temperature setting.

### Important

**The LCD displays by default the actual internal air temperature. It's important to understand that there is a difference between the air temperature inside the beverage cooler and the actual temperature of the beverages" You will need to wait approximately 12 hours before noticing the effects of temperature adjustment due to the critical mass within a full beverage cooler.**

**Once the thermostat is set it is strongly advised not to adjust it frequently. The thermostat will maintain the temperature inside the beverage cooler within a +/- 2.5 °C range, the actual temperature of the beverages will only fluctuate 0.5 °C to 1 °C.**

## Beverage Cooler Control panel

The LCD displays the internal air temperature. The desired temperature can be adjusted by pressing Set button and then Up and Down buttons, the temperature setting can be adjusted from 0 °C to 10 °C. Press Set button, the set temperature will temporarily flash in the LCD display for 5 seconds.



## Cooling Indicator light

When the light is on, the cooling mode is currently in operation.

## Interior Light

You can turn on/off the interior light by pressing the "Globe" button.

For the best storage condition, please keep the light off except while viewing.



## Instruction on how to replace the inside LED light .

Take off the screws from the lids, unplug LED light and then re-plug a new LED light to instead.



## INSTALLING STAINLESS STEEL HANDLE

This beverage cooler includes a stainless steel handle that is required to operate this unit.



To install the handle please follow the instruction below

1. Pull away the door gasket in the area where the handle is to be installed – you can see two designated holes for handle installation. The gasket is easily displaced by hand, no tools are necessary.
2. Install the handle tightly as shown below with the two screws. Lock washers and flat washers provided. (DO NOT over tighten as this will cause damage to the handle assembly and stainless steel surface of glass door).
3. Replace the door gasket to its original position.

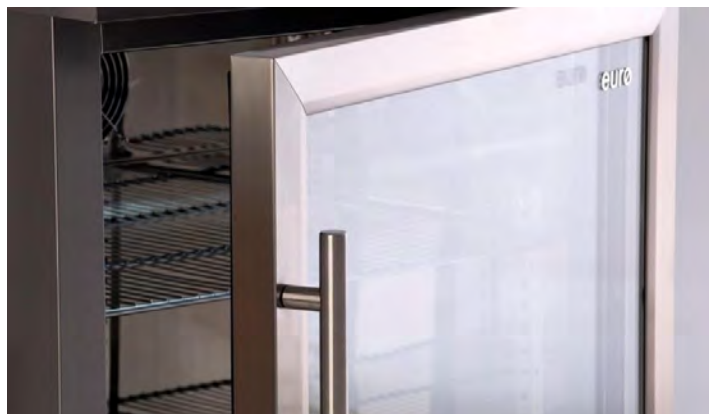

## Power Failures And Operation Anomalies

In the event of a power interruption, all previous temperature settings are automatically erased and the beverage cooler will revert to a preset temperature setting. Most power failures are corrected within a short period of time. A loss of power for an hour or two will not affect your beverage cooler's temperature. To avoid sudden change of temperature while the power is off, you should avoid opening the door. For a longer period of power failure, you may want to take steps to keep your beverages cool.

Ensure that there is power to the electrical supply plug by connecting another electrical appliance to it. Check Fuse, if any. Make sure that the door is closed properly.

If your beverage cooler appears to be malfunctioning, unplug it and contact EURO after sales service on 1800 440 335. Any service on the refrigeration circuit should be performed by a refrigeration technician who should carry out an inspection of the circuit sealing system. Similarly, any service on the electrical circuit should be performed by a qualified electrician.

### Important

**Any service performed by a non-technician will lead to the warranty being considered as null and void.**

### R600a Refrigerant Warning

- This appliance contains a small quantity of R600a refrigerant which is environmentally friendly, but flammable. It does not damage the ozone layer, nor does it increase the greenhouse effect.
- During transportation and installation, ensure that the tubing of the refrigerant circuit is not damaged
- Leaking refrigerant can ignite and may damage the eyes
- In the event any damage does occur, avoid exposure to open fires and any device which creates a spark. Disconnect the appliance from the mains power
- Thoroughly ventilate the room in which the appliance is located for several minutes.
- The room for installing the appliance must be at least 1 cubic metre per 8 grams of refrigerant. The refrigerant quantity contained in this appliance is noted on the rating plate of the appliance.
- Do not attempt to repair or replace any part of the bar fridge unless it is specially recommended in this manual, refer all other servicing to a qualified technician, or contact the after sales support line for advice on repair or replacement. It is hazardous for anyone other than an authorised service person to service this appliance. In Queensland, the authorised service person MUST hold a gas work authorisation for hydrocarbon refrigerants, to carry out servicing or repairs which involve the removal of covers.

## CARE AND MAINTENANCE

### Clean the condenser

The condenser must be kept clean and free of dust at all times. It is recommended that the cleaning routine be conducted at intervals appropriate to the speed of accretion of dust on the condenser. Failure to keep the condenser clean will damage the refrigeration system and invalidate the warranty.

#### Important

**The condenser is a delicate component and is easily damaged.  
Never use a stiff brush or sharp objects to clean it. Never use water.**

### Care when going on Vacation

1. Short Vacations

Leave the Beverage Cooler operating during vacations of less than 3 weeks.

2. Long Vacations

If the appliance will not be used for several months, remove all beverages and unplug the power cord. Clean and dry the interior thoroughly. To prevent odour and mould growth, leave the door open slightly; blocking it open if necessary or have the door removed. Do not leave access to children.

### Moving your Beverage Cooler

1. Remove all the beverages.
2. Securely tape down all loose items inside your appliance.
3. Tape the doors shut.
4. When fixed or moved, the beverage cooler cannot be set horizontally or reclined to more than 45° or positioned upside down.
5. Never move the beverage cooler while it is plugged in and operating.

### Energy saving tips

The beverage cooler should be located in the coolest location, away from heat producing appliance or heating ducts, and out of the direct sunlight.

Overloading the beverage cooler forces the compressor to run longer.

## Recommended Cleaning Product

- Switch off and disconnect from the power supply before cleaning
- Clean the interior of the appliance using the recommended products in accordance with local hygiene laws and regulations.
- Do not use abrasive cleaning agents, which may scratch and harm the delicate interior finishes of your appliance.
- Always wipe dry after cleaning.

### ▪ **AKTIVO All Purpose**

AKTIVO All Purpose Cleaner is our eco-friendly, natural, citrus fresh scented and strong cleaner for your homes. Designed to be gentle and non-toxic on surfaces, good for the environment but tough on stains and big cleaning jobs around the house.

Simply spray and wipe all surfaces with a clean cloth.



### ▪ **AKTIVO Glass + Window Cleaner**

AKTIVO Glass + Window Cleaner cleans all the glass surfaces without streaking. It dries quickly, keeping your glass shiny, gleaming and clear and it works without the use of choking ammonia fumes, leaving behind a mild citrus scent.

Spray a fine mist of our cleaner over the surface to be cleaned.

Immediately wipe over with a lint free cloth or clean dry paper towel.



### ▪ **AKTIVO Stainless Steel Polish**

AKTIVO Stainless Steel Polish is a light oil polish for stainless steel and architectural metals. It will remove finger marks instantly and retain a light film on the surface that resists further marking. Repels dirt and dust for long lasting shine.

Apply to a dry, lint free cloth and wipe lightly in the direction of the grain of the surface. For heavily soiled surfaces pre-clean with AKTIVO All Purpose Cleaner before applying. Do not apply onto plastic parts and moulding.



## TROUBLESHOOTING GUIDE

PROBLEM	POSSIBLE CAUSE
Beverage cooler does not operate	<p>Not plugged in.</p> <p>The appliance is turned off.</p> <p>The circuit breaker has tripped or a fuse has Blown.</p>
Beverage cooler is not cold enough.	<p>Check the temperature control setting.</p> <p>External environment may require a higher setting.</p> <p>The door is opened too often.</p> <p>The door is not closed completely.</p> <p>The door gasket does not seal properly.</p>
Turns on and off frequently	<p>The room temperature is hotter than normal.</p> <p>A large amount of contents has been added to the Beverage Cooler.</p> <p>The door is opened too often.</p> <p>The door is not closed completely.</p> <p>The temperature control is not set correctly.</p> <p>The door gasket does not seal properly.</p>
The light does not work	<p>Not plugged in.</p> <p>The circuit breaker tripped or a blown fuse.</p> <p>The bulb has burned out.</p> <p>The light button is "OFF".</p>
Vibrations	<p>Check to assure that the Beverage Cooler is Level.</p>
Beverage cooler seems to make too much noise.	<p>Some noise may come from the flow of the refrigerant, which is normal.</p> <p>As each cycle ends, you may hear gurgling sounds caused by the flow of refrigerant in your Beverage Cooler.</p> <p>Contraction and expansion of the inside walls may cause popping and crackling noises.</p> <p>The Beverage cooler is not level.</p>
The door will not close properly.	<p>The Beverage Cooler is not level.</p> <p>The door was reversed and not properly installed.</p> <p>The gasket is dirty.</p> <p>The shelves are out of position.</p>

### Important

**If the appliance appears not to be operating correctly, turn off the appliance at the switch and then contact the Service Department for advice.**

**Do not attempt to repair the appliance yourself**

# TECHNICAL SPECIFICATIONS

## EA60 Series Stainless Steel Beverage Cooler

Item Number	EA60WFSX2L	EA60WFSX2R	EA60SDSXL	EA60SDSXR
<b>Stype</b>	Stainless Steel Glass Door Left Door open	Stainless Steel Glass Door Right Door open	Stainless Steel Solid Door Left Door Open	Stainless Steel Solid Door Right Door Open
<b>Cooling System</b>	Compressor Cooling		Compressor Cooling	
<b>Volumn</b>	128L		128L	
<b>Climate Glass</b>	T		T	
<b>Rated Voltage</b>	AC220V-240V / 50Hz		AC220V-240V / 50Hz	
<b>Rated Current</b>	1.0A		1.0A	
<b>Energy Consump.</b>	0.83kW.h/24h		0.83kW.h/24h	
<b>Refrigerant</b>	R600a		R600a	
<b>Charging Amount</b>	35g		35g	
<b>Temp.Range</b>	0-10'C		0-10'C	
<b>Unit Size</b>	600x500x840mm		600x500x840mm	
<b>Net Weight</b>	37kgs		37kgs	

**EA60WFSX2L**



**EA60WFSX2R**



**EA60SDSXL**



**EA60SDSXR**



## EA60 Series Black Beverage Cooler

Item Number	EA60WFBL	EA60WFBR	EA60WSDBL	EA60WSDBR
<b>Stype</b>	Black Frame Glass Door Left Door open	Black Frame Glass Door Right Door open	Black Frame Solid Door Left Door Open	Black Frame Solid Door Right Door Open
<b>Cooling System</b>	Compressor Cooling		Compressor Cooling	
<b>Volumn</b>	128L		128L	
<b>Climate Glass</b>	T		T	
<b>Rated Voltage</b>	AC220V-240V / 50Hz		AC220V-240V / 50Hz	
<b>Rated Current</b>	1.0A		1.0A	
<b>Energy Consump.</b>	0.83kW.h/24h		0.83kW.h/24h	
<b>Refrigerant</b>	R600a		R600a	
<b>Charging Amount</b>	35g		35g	
<b>Temp.Range</b>	0-10'C		0-10'C	
<b>Unit Size</b>	600x500x840mm		600x500x840mm	
<b>Net Weight</b>	37kgs		37kgs	

**EA60WFBL**



**EA60WFBR**



**EA60WSDBL**



**EA60WSDBR**



## EA90 Series Beverage Cooler

Item Number	EA90SDSX	EA900WFSX2	EA900WFBL	EA900WSDB
Stype	Stainless Steel Solid Door	Stainless Steel Glass Door	Black Frame Glass Door	Black Frame Solid Door
Cooling System	Compressor Cooling		Compressor Cooling	
Volumn	208L		208L	
Climate Glass	T		T	
Rated Voltage	AC220V-240V / 50Hz		AC220V-240V / 50Hz	
Rated Current	1.3A		1.3A	
Energy Consump.	1.2kW.h/24h		1.2kW.h/24h	
Refrigerant	R600a		R600a	
Charging Amount	50g		50g	
Temp.Range	0-10'C		0-10'C	
Unit Size	900x500x840mm		900x500x840mm	
Net Weight	53.5kgs		53.5kgs	

**EA90SDSX**



**EA900WFSX2**



**EA900WFBL**



**EA900WSDB**





# WIRING DIAGRAM (60 Series)

## EA60WFSX2L

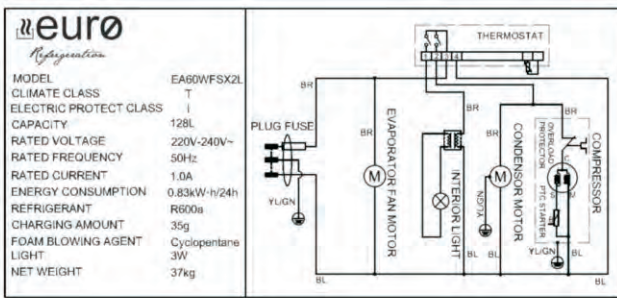

EUROSTYLE GROUP PTY LTD  

## EA60WFSX2R

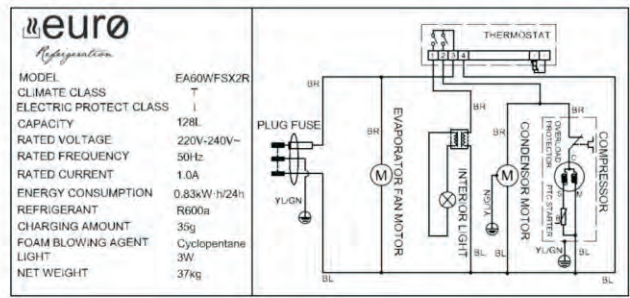

EUROSTYLE GROUP PTY LTD  

## EA60SDSXL

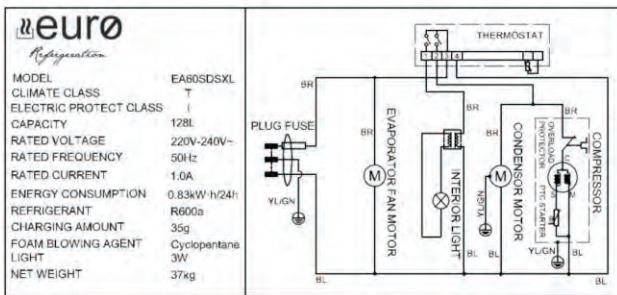

EUROSTYLE GROUP PTY LTD  

## EA60SDSXR

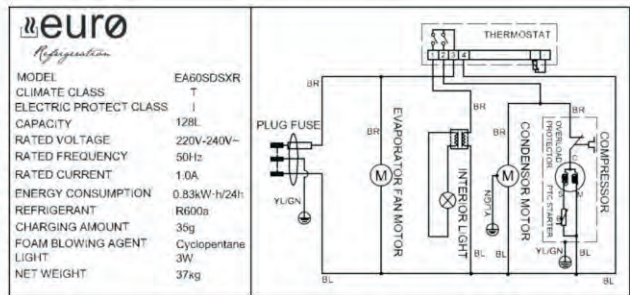

EUROSTYLE GROUP PTY LTD  

## EA60WFBL

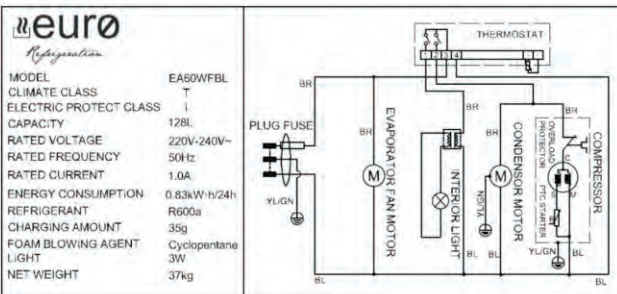

EUROSTYLE GROUP PTY LTD  

## EA60WFBR

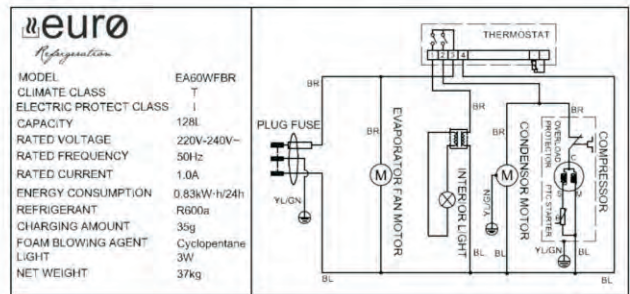

EUROSTYLE GROUP PTY LTD  

## EA60WSDBL

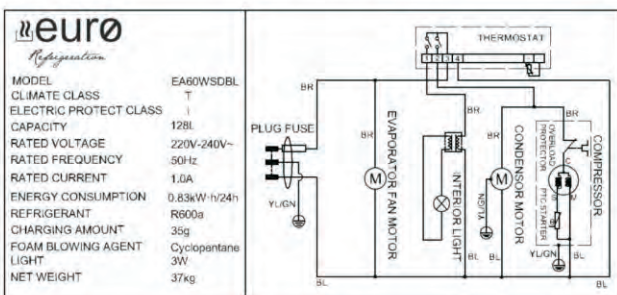

EUROSTYLE GROUP PTY LTD  

## EA60WSDBR

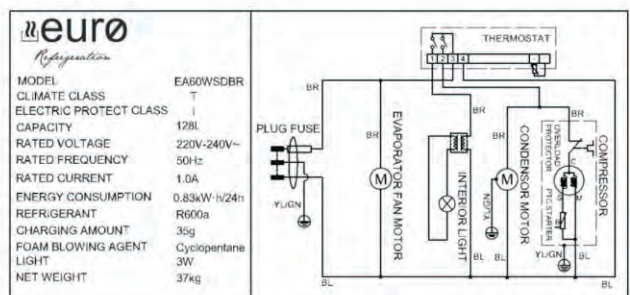

EUROSTYLE GROUP PTY LTD  

# WIRING DIAGRAM (90/900 Series)

**EA90SDSX**

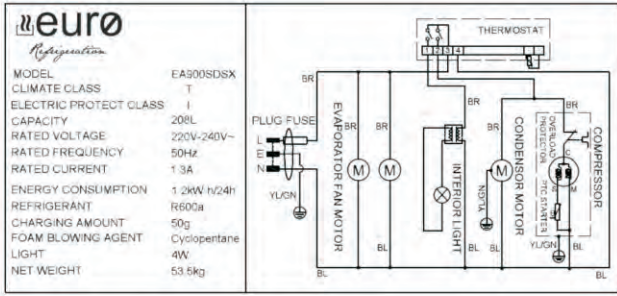

EUROSTYLE GROUP PTY LTD



**EA900WFSX2**

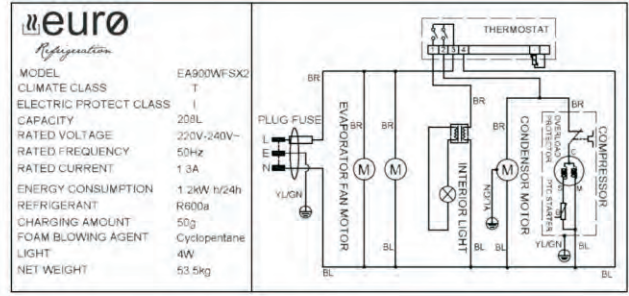

EUROSTYLE GROUP PTY LTD



**EA900WFBL**

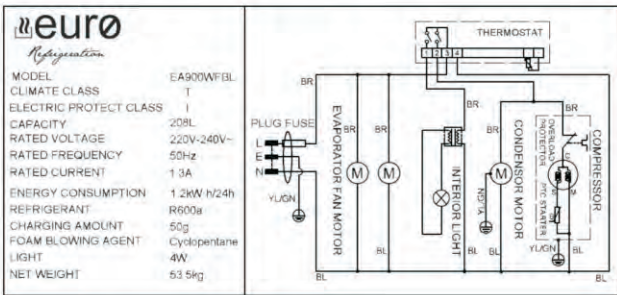

EUROSTYLE GROUP PTY LTD



**EA900WSDB**

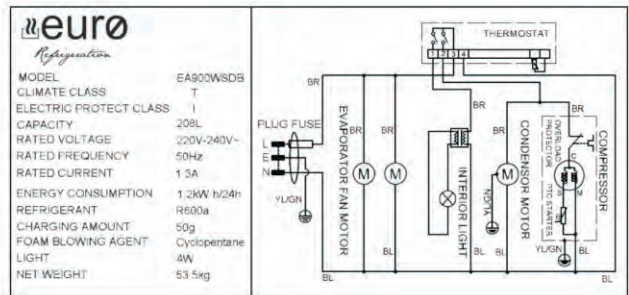

EUROSTYLE GROUP PTY LTD



## DIMENSION DRAWINGS

**EA900WFSX2 - EA900WFBL**

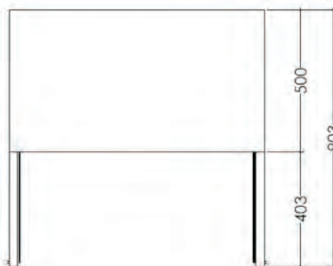
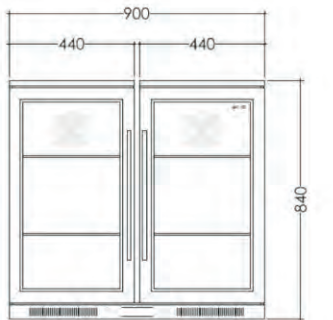

**EA90SDSX - EA900WSDB**

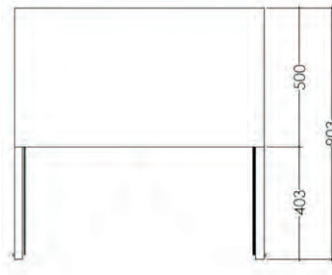
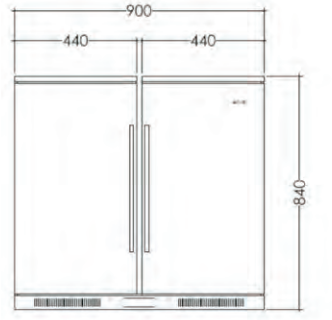

# DIMENSION DRAWINGS

**EA60WFSX2L - EA60WFBL**

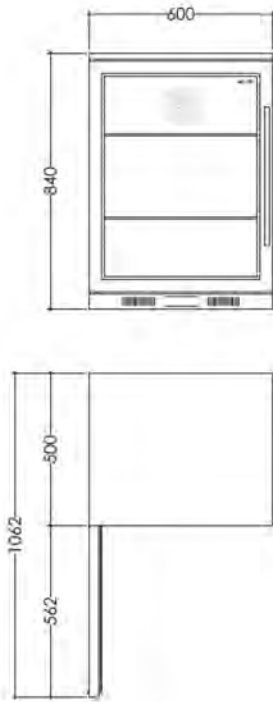

**EA60SDSXR - EA60WSDBR**

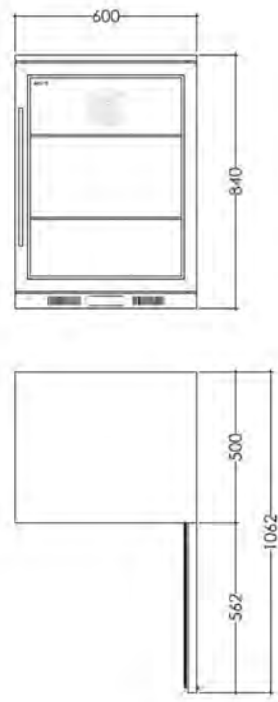

**EA60SDSXL - EA60WSDBL**

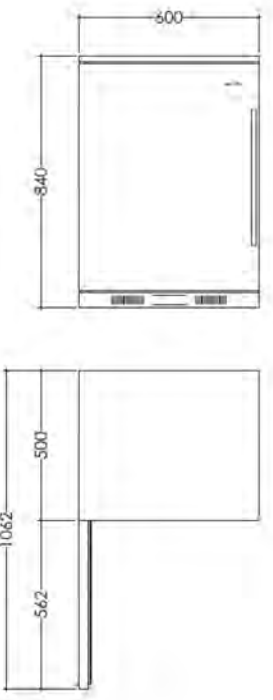

**EA60SDSXR - EA60WSDBR**

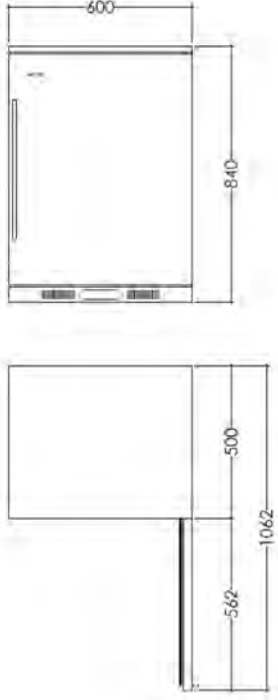

# SPARE PARTS

**Exploded view of model SC-128F**

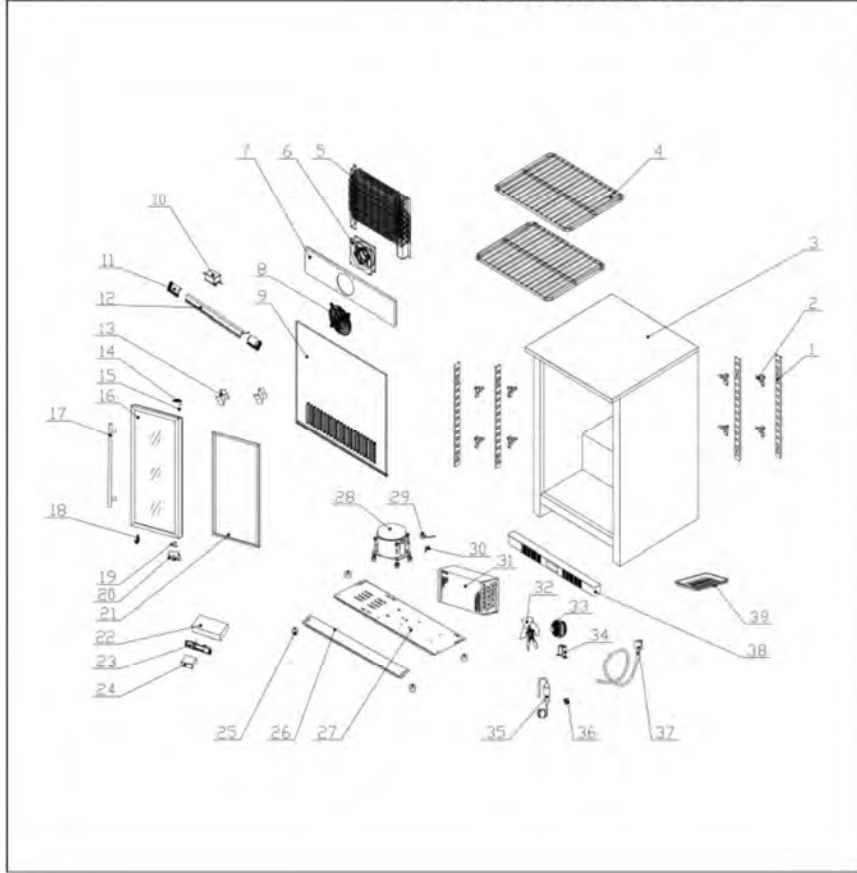

Serial No	NO./Part Number	Description	Qty for each cabinet
1	211.0335.00	K-bracket	4
2	223.000.00	K-clip	8
3		Foaming body (black)	1
4	201.SC128F.00	Shelf	2
5	521.SC128F.00	Evaporator	1
6	402.12025.01	Evaporator-fin	1
7	16.211.SC128F.10	Evaporator install panel (#3045S)	1
8	273.000.00	Fan cover	1
9	16.221.SC128F.10	Evaporator bottom panel	1
10	417.3000.05	LED drawer	1
11	350.002.100	Light clamp	2
12	434.SC118F.00	LED light	1
13	350.001.02	Install bracket	2
14	263.000.00	Upper hinge	2
15	352.08.00	Upper hinge sleeve	1
16	911.SC128F.35	Glass door (Left hinge)	1
	911.SC128F.33	Glass door (Right hinge)	1
17	241.405.01	Door handle	1
18	255.000.00	Door lock	1
19	352.08.00	Bottom hinge sleeve	1
20	262.000.01	Bottom hinge	1
21	912.SC128F.00	Gasket	1
22		Controller cover	1
23	366.000.01	Controller install panel	1
24	411.ECS.00	Digital controller	1
25	233.10.00	Feet	4
26	16.232.SC128F.01	Front feet install panel	1
27	16.231.SC128F.01	Compressor install panel	1
28	501.EYD60.00	Compressor	1
29		Compressor starter	1
30		Compressor Over-load protector	1
31	512.SC128F.00	Condenser	1
32	282.100.10	Condenser fan blade	1
33	401.YZF5.00	Condenser fan motor	1
34	283.55.00	Condenser fan supporter	1
35	541.15.00	Filter	1
36	842.000.00	Filter install bracket	1
37	451.001.01	Power cord	1
38	16.202.SC128F.00	Front panel	1
39	371.000.02	Water tray	1

**Exploded view of model SC-208F**

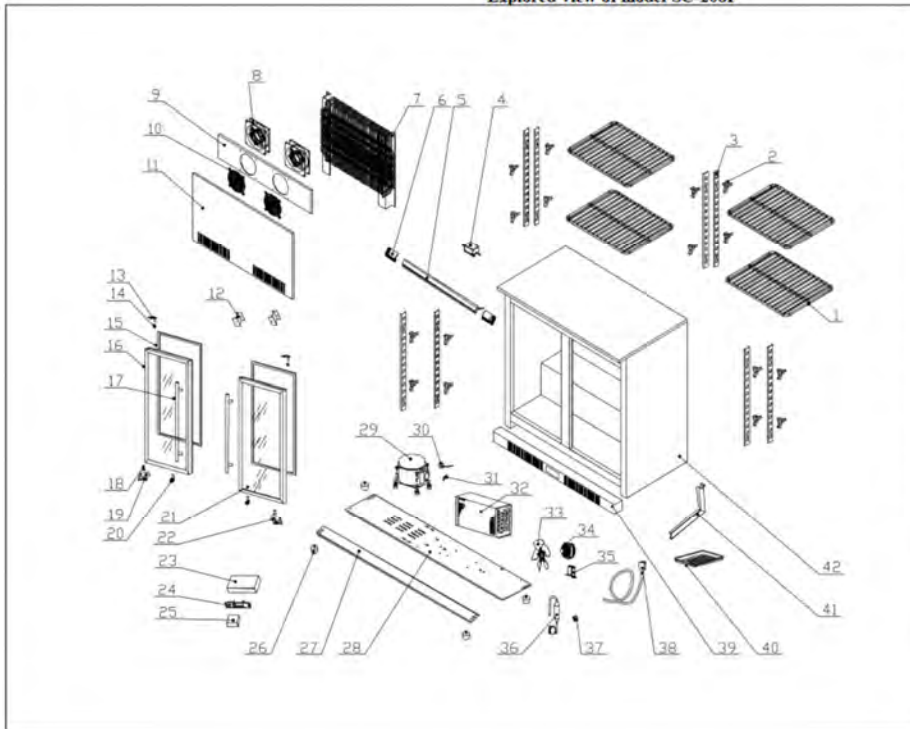

Serial No	NO./Part Number	Description	Qty for each cabinet
1	301.SC118F.00		4
2	223.000.00	K-bracket	16
3	311.0335.00	K-clip	8
4	417.3000.03	LED drawer	1
5	434.SC128F.00	LED light	1
6	350.002.100	Light clamp	2
7	521.SC128F.00	Evaporator	1
8	402.12025.01	Evaporator-fin	2
9	16.211.SC208F.10	Evaporator install panel (#3045S)	1
10	273.000.00	Fan cover	2
11	16.221.SC208F.10	Evaporator bottom panel (#3045S)	1
12	350.001.02	Install bracket	3
13	263.000.00	Upper hinge	1
14	352.08.00	Upper hinge sleeve	1
15	912.SC208F.00	Gasket	2
16	911.SC208F.80	Left glass door	1
17	241.405.01	Door handle	2
18	352.08.00	Bottom hinge sleeve	1
19	261.000.01	Left Bottom hinge	1
20	255.000.00	Door lock	2
21	911.SC208F.61	Right glass door	1
22	262.000.01	Right Bottom hinge	1
23		Controller cover	1
24	366.000.01	Controller install panel	1
25	411.ECS.00	Digital controller	1
26	233.10.00	Feet	4
27	16.232.SC208F.01	Front feet install panel	1
28	16.231.SC208F.01	Compressor install panel	1
29	502.CS807.02	Compressor	1
30		Compressor starter	1
31		Compressor Over-load protector	1
32	511.SC228F.00	Condenser	1
33	282.100.10	Condenser fan blade	1
34	401.YZF5.00	Condenser fan motor	1
35	283.55.00	Condenser fan supporter	1
36	541.15.00	Filter	1
37	842.000.00	Filter install bracket	1
38	451.001.01	Power cord	1
39	16.202.SC208F.00	Front panel	1
40	371.000.02	Water tray	1
41	16.234.SC208F.02	Reinforce bracket	1
42		Foaming body (Black)	1

**Note : The information in this document is subject to modification without any prior notice.**



**Pronto** Service + Support: 1800 440 335  
Email: [service@eurostylegroup.com.au](mailto:service@eurostylegroup.com.au)

HEAD OFFICE

65 Glynburn Road, Glynde SA 5070  
Ph: 08 8165 1012

**[www.euroappliances.com.au](http://www.euroappliances.com.au)**